

# Advantage

Gold Series by Ebtron

## ***GTx116 “Plug & Play” Transmitters Installation & Configuration Guide***

### **Firmware Version 4.xx**

Includes Analog output models: GTA116-P, GTA116-F & GTA116-B

Includes RS-485 output models: GTN116-P, GTN116-F & GTN116-B

Includes Ethernet output models: GTE116-P, GTE116-F & GTE116-B

Includes LonWorks® output models: GTL116-P, GTL116-F & GTL116-B

*Document Name: GTx116\_Trans\_Manual400\_108*

***“Configuration is a Feature, not a requirement on Plug & Play Transmitters”***



# ***EBTRON***

Thermal Dispersion Airflow Measurement

1663 Hwy. 701 S., Loris, SC 29569 USA  
Toll Free: 800-2EBTRON (232.8766) Fax: 843.756.1838  
Internet: [www.ebtron.com](http://www.ebtron.com) e-mail: [ebtron@ebtron.com](mailto:ebtron@ebtron.com)

# Index

## GTX116 Transmitter Installation & Configuration Guide

<b>OVERVIEW</b> .....	Page 3
<b>TECHNICAL</b> .....	Page 4
<b>PHYSICAL INSTALLATION</b> .....	Page 5
<b>POWER &amp; PROBE CONNECTIONS</b>	
24VAC POWER CONNECTION.....	Page 6
SENSOR PROBE CONNECTION.....	Page 7
<b>SIGNAL WIRE CONNECTIONS</b>	
GTA116 ANALOG OUTPUT TRANSMITTERS.....	Page 8
GTN116 RS-485 OUTPUT TRANSMITTERS.....	Page 10
GTE116 ETHERNET OUTPUT TRANSMITTERS.....	Page 12
GTL116 LonWorks® OUTPUT TRANSMITTERS.....	Page 14
<b>START-UP &amp; OPERATION</b> .....	Page 16
<b>SETUP MENU OPTIONS I-P &amp; S.I. UNITS</b>	
GTx116-P & GTx116-F & GTx116B/I-P UNITS .....	Page 19
GTx116-P & GTx116-F & GTx116B/S.I. UNITS.....	Page 21
DIAGNOSTICS.....	Page 23
<b>ADJUSTMENTS</b> .....	Page 24
<b>TROUBLESHOOTING GUIDE</b> .....	Page 26

### GTx116 Quick Start Guide

1. Connect the 24 VAC power wires to positions L1 and L2 of the power terminal block.
2. Connect the cable from the sensor probes to the receptacles on the bottom of the GTx116 transmitter.
3. Connect the output signal wires to the proper position of the GTx116 transmitter:
  - GTA116: Position 1 and COM for flow and 2 and COM for temperature on the OUTPUT terminal block.
  - GTN116: Position 1 for A and 2 for B (COM is optional for common) on the OUTPUT terminal block.
  - GTE116: The RJ45 connector labeled “10 Base-T Ethernet Connection” on the output card.
  - GTL116: Positions 1 and 2 on the OUTPUT terminal block.
4. Configure the output card for use with the host controls or network:
  - GTA116: Set switches SW1 and SW2 for mA or VDC output signals.
  - GTN116: Set the DIP switches for PROTOCOL, ADDRESS and TERMINATION.
  - GTE116: Set the SW1 DIP switches for the desired protocol.
  - GTL116: There are no options to set on the output card.
5. Slide the power switch to the ON position.
6. Adjust transmitter output communication for use with the host controls or network:
  - GTA116: Optional - see guide for details.
  - GTN116: No adjustments.
  - GTE116: Required - see guide for details.
  - GTL116: Required - see guide for details.



## Features

- Microprocessor-based electronics.
- “Plug and Play” design.
- Accepts up to 16 individual airflow and temperature sensors.
- LCD display.
- Push-button user interface for simple field configuration and diagnostics.
- Airflow and temperature output.
- Analog output signals and network protocols interface with all building automation systems.

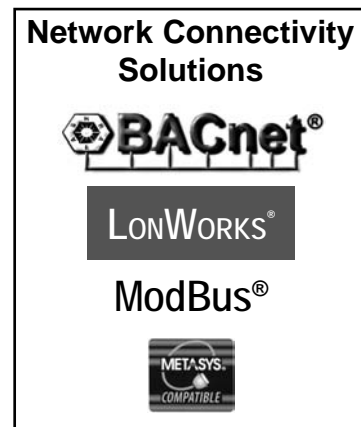

## Description

**EBTRON**'s top-of-the-line GTx116 transmitter can process up to 16 individual sensing points and is compatible with a number of **EBTRON** sensor systems. The transmitter requires 24 VAC and provides the host controls with output signals for airflow and temperature.

Each transmitter is fully independent of the sensor probes and does not require field matching to sensor probes.

All GTx116 transmitters include a 16 character LCD display that indicates airflow, temperature and system status. The display is also used during configuration and diagnostic modes. Field configuration is accomplished using a simple four-button interface on the main circuit board. Individual airflow and temperature measurements can be displayed from the diagnostic mode and are beneficial as an HVAC system diagnostic tool. The airflow output signal can be filtered and a process low limit can be set that forces the output to zero when the airflow rate falls below the user defined value. Both features are beneficial on outside air intakes that are affected by transient wind gusts at low airflow rates. An output signal offset and gain can be set using the four button interface for installations that require field calibration or adjustment.

### Connectivity

Output to Host Controls	Output/Protocols Supported	Airflow	Temperature	Status
Analog x=A	Linear 0-10VDC or 4-20mA	Yes	Yes	Visual Only
RS-485 x=N	BACnet-MS/TP	Yes	Yes	Yes
	ModBus-RTU			
	JCI N2-Bus			
Ethernet x=E	BACnet Ethernet	Yes	Yes	Yes
	BACnet-IP			
	ModBus-TCP			
	TCP/IP			
LonWorks x=L	Free Topology Transceiver	Yes	Yes	Yes

### Transmitter Specifications

<b>Maximum Number of Sensing Points</b>	16 (16 airflow + 16 temperature, independently processed)
<b>Sensor System Configurations (max.)</b>	
Type A (probes x sensors/probe)	2x8 (GP1 probes)
Type B (probes x sensors/probe)	4x4 (GP1 probes), 4x1 (GF1 fan inlets & GB1 "bleed" sensors)
<b>Microprocessor</b>	Yes
<b>Multiplexing</b>	32 individual channels
<b>A/D Converter</b>	12-Bit
<b>"Plug and Play" Sensor Systems</b>	Yes, probes do not require matching to transmitter
<b>Power Requirements</b>	
Voltage	24 VAC (22.5 to 29 VAC), isolation not required
"Brownout" protection	Yes, using "watchdog" reset circuitry
Power	20 VA max. (dependent on number of sensors)
Protection	Over voltage, over current and surge protection
<b>Enclosure</b>	Aluminum
<b>Output to Host Controls</b>	
Output/Protocols Supported	Isolated 0-10VDC or 4-20mA (resolution 0.025% F.S.)
	RS-485, 76.8 Kbps max., BACnet <sup>®</sup> , ModBus <sup>®</sup> , JCI N2-Bus <sup>®</sup>
	Ethernet, 10 BaseT, BACnet <sup>®</sup> , ModBus <sup>®</sup> , TCP/IP
	LonWorks <sup>®</sup> Free Topology Transceiver
Airflow Output Adjustments	Offset/gain (pushbutton LCD display)
Airflow Output Signal Filter	0 (off) to 99% (pushbutton LCD display)
Airflow Low Limit Cutoff	Forces output to zero below user defined value
<b>Display</b>	16 character alpha-numeric display (auto-ranging)
<b>User Interface</b>	Pushbutton and LCD display
<b>System Diagnostics</b>	Sensor/transmitter diagnostic mode with notification
<b>Environmental Limits</b>	
Operating Temperature	-20° F to 120° F (-28.88° C to 48.88° C)
Moisture	0 to 99% RH, non condensing (protect from water)
<b>Compatible Sensor Systems</b>	GP1 probes, GF1 fan inlets, and GB1 "bleed" sensors
<b>UL<sup>®</sup> Listed</b>	UL <sup>®</sup> 873 Airflow & Temperature Indicating Devices
<b>Warranty</b>	36 months from shipment

### Mounting

The **GTx116** transmitter aluminum chassis has been designed for use in an environment between  $-20^{\circ}\text{ F } (-28.8^{\circ}\text{ C})$  and  $120^{\circ}\text{ F } (48.8^{\circ}\text{ C})$  where it will not be exposed to rain or snow.

The transmitter should be mounted upright in a field accessible location. The chassis is designed to accept  $3/4"$  (19.0 mm) conduit fittings for signal and power wiring at the top left and right of the enclosure. The transmitter should be located such that the connecting cables from all of the sensor probes reach the receptacles on the bottom of the transmitter enclosure.



Do not expose the transmitter to rain or snow without providing a NEMA4 enclosure.



Leave at least  $10"$  (254.0 mm) above, and  $2"$  (50.8 mm) to each side and bottom, of unobstructed space around the transmitter to allow for heat dissipation and cover removal.



Locate the transmitter in a location that can be reached by all connecting cables from the sensor probes.



Do not drill into the transmitter chassis since metal shavings could damage the electronics.

### Transmitter Dimensions

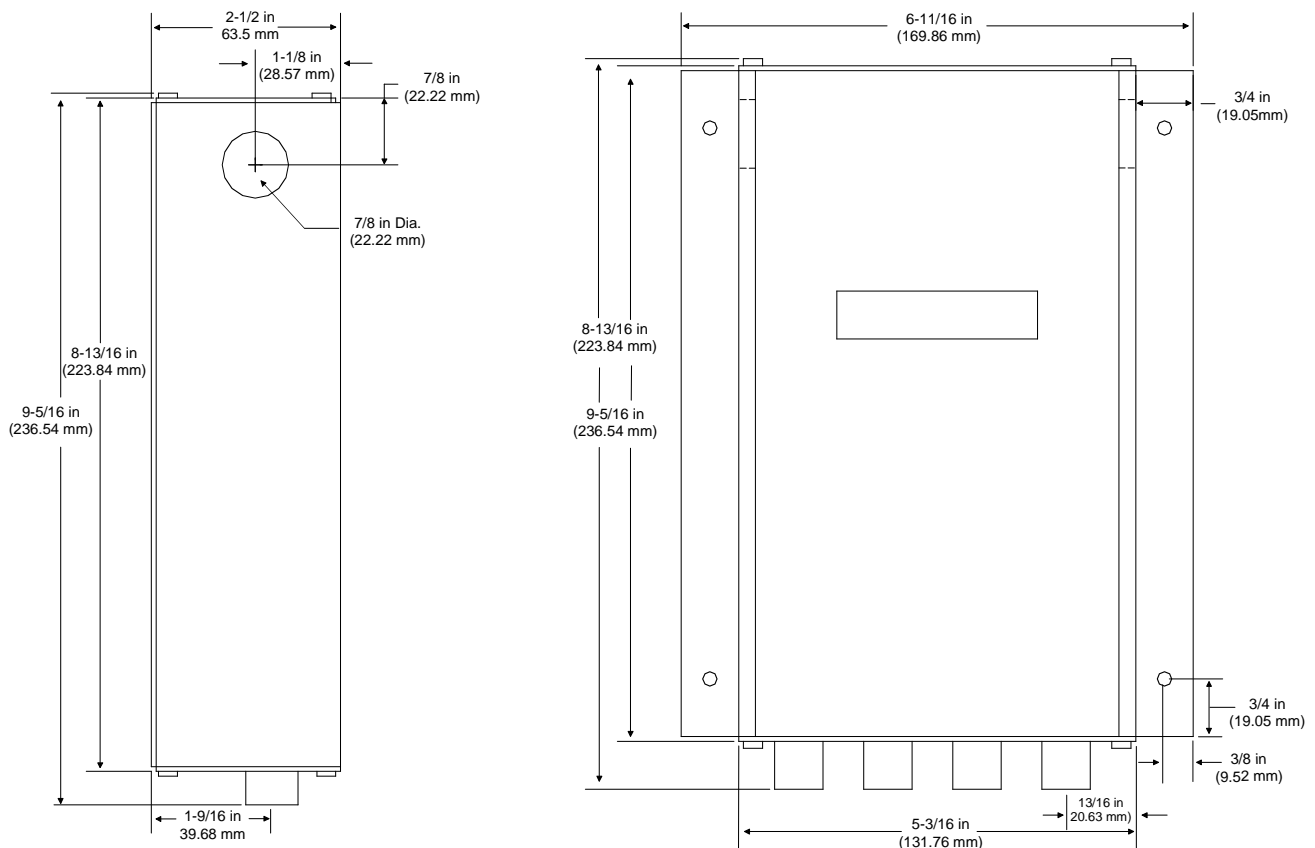

### Transformer Selection

Select a 24VAC transformer based on the maximum power requirements indicated on the transmitter label (20 VA) or from the table below. The operating supply voltage (transmitter power “ON” with all sensor probes connected) should not be less than 22.5 VAC or greater than 29 VAC.

### Transmitter Power Requirements

Total Sensors	Minimum VA Req.	Total Sensors	Minimum VA Req.	Total Sensors	Minimum VA Req.	Total Sensors	Minimum VA Req.
1	12	5	14	9	17	13	19
2	13	6	15	10	17	14	19
3	13	7	15	11	18	15	20
4	14	8	16	12	18	16	20

### Connecting Power to the Transmitter

Slide the cover plate up and out of the transmitter’s extruded aluminum chassis and make sure that the power switch is in the “OFF” position before connecting your 24 VAC power source.

Connect 24 VAC power to the large, two position power input terminal labeled “POWER” on the upper right hand side of the main circuit board. Since the output signals are isolated from the power supply, it is not necessary to provide an isolated (secondary not grounded) power source.



Multiple GTx116 transmitters wired to a single transformer must be wired “in-phase” (L1 to L1, L2 to L2).



Sensor probes must be connected to the transmitter before turning the power switch to the “on” position to properly “flash” sensor calibration data to the transmitter.

### Input Power Diagram

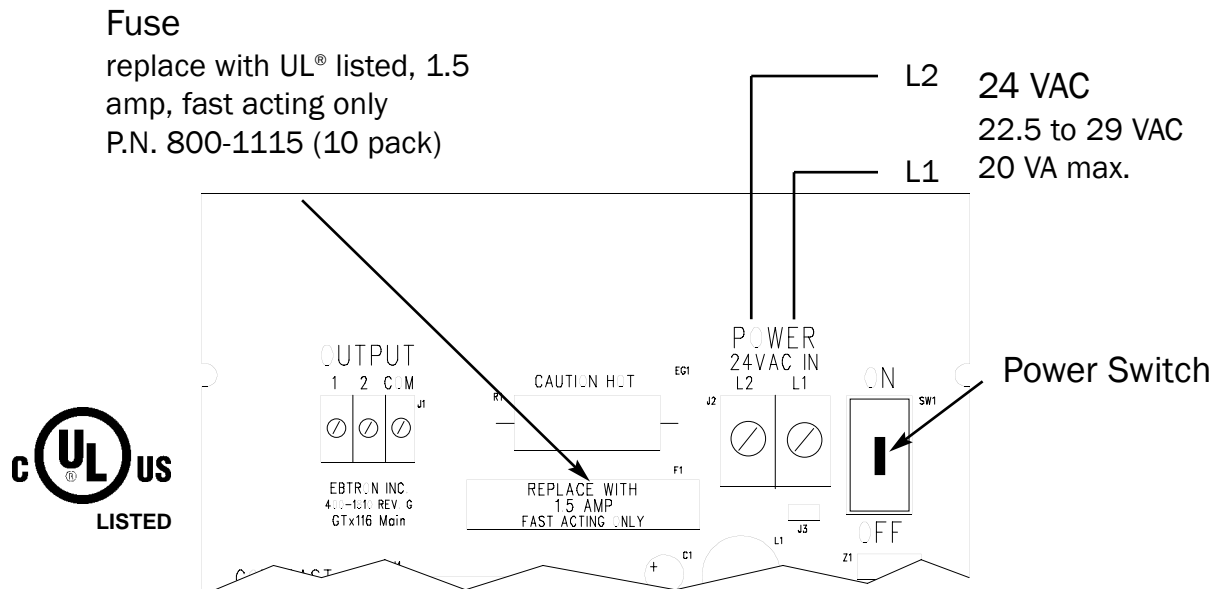

### Connecting Sensor Probes to Transmitter

After mounting the sensor probes and transmitter, connect one or more sensor probe cable plugs to the circular receptacles located at the bottom of the **GTx116** transmitter enclosure. Probes are “*Plug and Play*” and do not have to be connected to a specific receptacle on the transmitter. Transmitters can accept GP1, GF1 or GB1 sensors. Mixing sensor types on a single transmitter is not permitted. Match probes to transmitter by type (A or B) as indicated on the tags on the transmitter and sensor probes.



Provide a “drip loop” at the transmitter if there will be the potential for water runoff or condensation along the sensor probe cable(s).



Sensor probe cable plugs are “keyed”. Line up plug with receptacle and push straight on to receptacle. **DO NOT TWIST.** Squeeze cable plug “ribs” towards receptacle when removing. Forcing the cable plug in or out of the receptacle will damage the connectors and void warranty.

#### Type A Transmitter



Accepts 1 or 2 probes up to 8 sensors each.

#### Type B Transmitter



Accepts 1 to 4 probes up to 4 sensors each.

### Connecting Cable Plugs to Transmitter

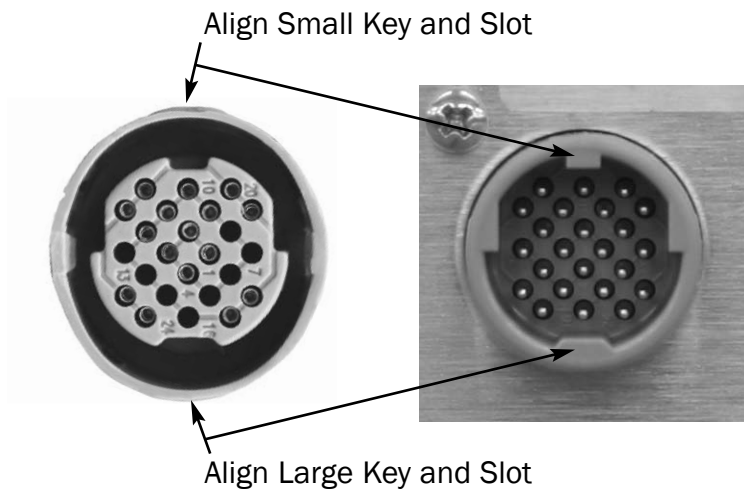

Cable Plug

Transmitter

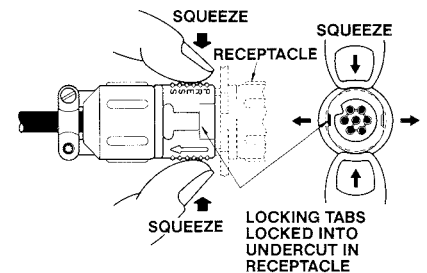

Squeeze and Pull to Remove  
**DO NOT TWIST!**

### GTA116 Analog Output Transmitters

The GTA116 provides two independent over voltage and over current protected 12-bit (4096 discrete states) linear analog outputs. In order to facilitate easily, integrating with various building automation systems, each output is field selectable 0-10VDC or 4-20mA and is galvanically and optically isolated from the main power supply.



**When configured for a 4-20 mA output, the GTA116 is a “4-wire” device. The host controls should not provide any excitation voltage to the output of the GTA116.**

To wire the output signal, slide the cover plate up and out of the extruded chassis. Make sure that the power switch is in the “OFF” position. Signal wires for airflow rate and temperature should be connected to the small, three position output terminal labeled “OUTPUT” on the upper left hand side of the main circuit board as indicated in the figure below.

### Analog Output Circuit Diagram

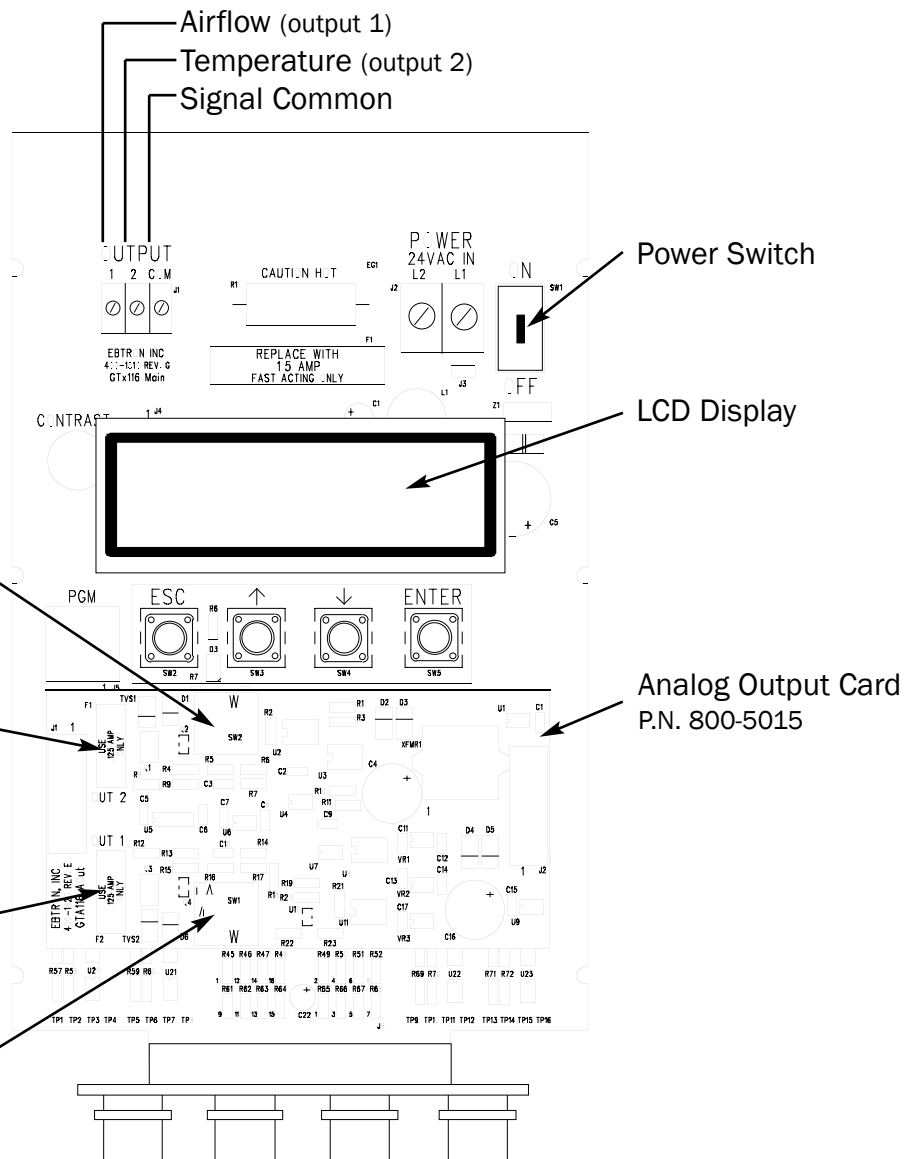

**Switch 2**  
Temperature Output  
4-20mA or 0-10VDC  
default: 4-20mA

**Output 2 Fuse**  
Temperature Output  
Replace with UL® listed,  
0.125 Amp only.  
P.N. 800-1105 (10 Pack)

**Output 1 Fuse**  
Airflow Output  
Replace with UL® listed,  
0.125 Amp only.  
P.N. 800-1105 (10 Pack)

**Switch 1**  
Airflow Output  
4-20mA or 0-10VDC  
default: 4-20mA

The transmitter is factory shipped with the analog output signals set to the 4-20mA default. If a 0-10 VDC output is desired, simply move the corresponding switch (SW1 for Output 1, SW2 for Output 2) to the 0-10 VDC position.



**The transmitter is factory shipped with the analog output signals set to the 4-20mA default. If a 0-10 VDC output is desired, move the corresponding switch to the 0-10 VDC position.**

Since the accuracy of the GTA116 is “percent of reading” there should be no need to reconfigure the default output scales listed inside of the transmitter cover. However, factory default settings can be easily reconfigured in the field (see: *Changing Factory Default Settings*).

The equivalent volumetric flow full scale reading can easily be determined by multiplying the full scale reading by the free area where the airflow measuring station is located (free area x 1000 for S.I. scaling when the area is calculated in square meters). For -P units, the free area is printed on the hang-tag of each sensor probe. For -F and -B units, the free area should be determined after the units are installed.

## Converting Analog Output Signals to Airflow & Temperature

### Converting 0-10 VDC to:

#### Unidirectional Airflow (-P and -F sensors)

Airflow (FPM, m/s) = Output Voltage/10 x FS1  
Airflow (CFM) = Area (sq.ft.) x Output Voltage/10 x FS1  
Airflow (L/s) = Area (sq.m) x 1000 x Output Voltage/10 x FS1

#### Unidirectional Airflow (-B sensors)

Airflow (FPM, m/s) = Output Voltage/10 x FS1  
Airflow (CFM, L/s) = K x Output Voltage/10 x FS1  
where K is established by field measurement

#### Unidirectional Differential Pressure (-B sensors only)

Airflow (in.w.g., Pa) = Output Voltage/10 x FS1

#### Bidirectional Airflow (-B sensors only)

Airflow (FPM) = (Output Voltage - 5)/5 x FS1  
Airflow (CFM, L/s) = K x (Output Voltage - 5)/5 x FS1  
where K is established by field measurement

#### Bidirectional Differential Pressure (-B sensors only)

Airflow (in.w.g.) = (Output Voltage - 5)/5 x FS1

#### Temperature (-P,-F and -B sensors)

Temp (°F, °C) = Output Voltage/10 x (FS2 - MS2) + MS2

### Converting 4-20 mA to:

#### Unidirectional Airflow (-P and -F sensors)

Airflow (FPM, m/s) = (Output Current\* - 4)/16 x FS1  
Airflow (CFM) = Area (sq.ft.) x (Output Current - 4)/16 x FS1  
Airflow (L/s) = Area (sq.m) x 1000 x (Output Current - 4)/16 x FS1

#### Unidirectional Airflow (-B sensors)

Airflow (FPM, m/s) = (Output Current - 4)/16 x FS1  
Airflow (CFM, L/s) = K x (Output Current - 4)/16 x FS1  
where K is established by field measurement

#### Unidirectional Differential Pressure (-B sensors only)

Airflow (in.w.g., Pa) = (Output Current - 4)/16 x FS1

#### Bidirectional Airflow (-B sensors only)

Airflow (FPM) = (Output Current - 12)/8 x FS1  
Airflow (CFM, L/s) = K x (Output Current - 12)/8 x FS1  
where K is established by field measurement

#### Bidirectional Differential Pressure (-B sensors only)

Airflow (in.w.g.) = (Output Current - 12)/8 x FS1

#### Temperature (-P,-F and -B sensors)

Temp (°F, °C) = (Output Current - 4)/16 x (FS2 - MS2) + MS2

\* Output Current is in mA

## Sending a Test Output Signal to the Host Control System

A test output signal between 0 and 100% of the full scale output (0 to 10 VDC or 4 to 20 mA) can be provided by the GTA116 transmitter to verify proper conversion of the output signals from the GTA116 transmitter at the host control system.

To set a fixed output signal for airflow and temperature, simultaneously press and release the “ENT” and “ESC” button within 10 seconds of power up. Use the “DOWN” arrow button until “\*TESTOUT=0%” is displayed. Press the “ENT” button and use the “UP” and “DOWN” arrow buttons to set the output between 0 and 100% of the full scale. Press the “ESC” button until you return to the normal operating mode.

### GTN116 RS-485 Output Transmitters

The GTN116 provides a differential bus/line transceiver designed to meet the requirements of the RS-485 standard for multipoint data transmission. Bus contention or wiring fault conditions are protected by current and voltage, limiting the individual output terminals as well as an automatic thermal shutdown of the RS-485 transceiver. The GTN116 presents a ¼ unit load to the network which allows 128 nodes to be present on the network segment. Flexibility to integrate with various network protocols and topologies is provided via on-board field selectable option switches for address selection, line termination and protocol.

To wire the output signal, slide the cover plate up and out of the extruded chassis. Make sure that the power switch is in the “OFF” position. Twisted pair signal wires should be connected to the small, three position output terminal labeled “OUTPUT” on the upper left hand side of the main circuit board as indicated in the figure below.

### RS-485 Output Circuit Diagram

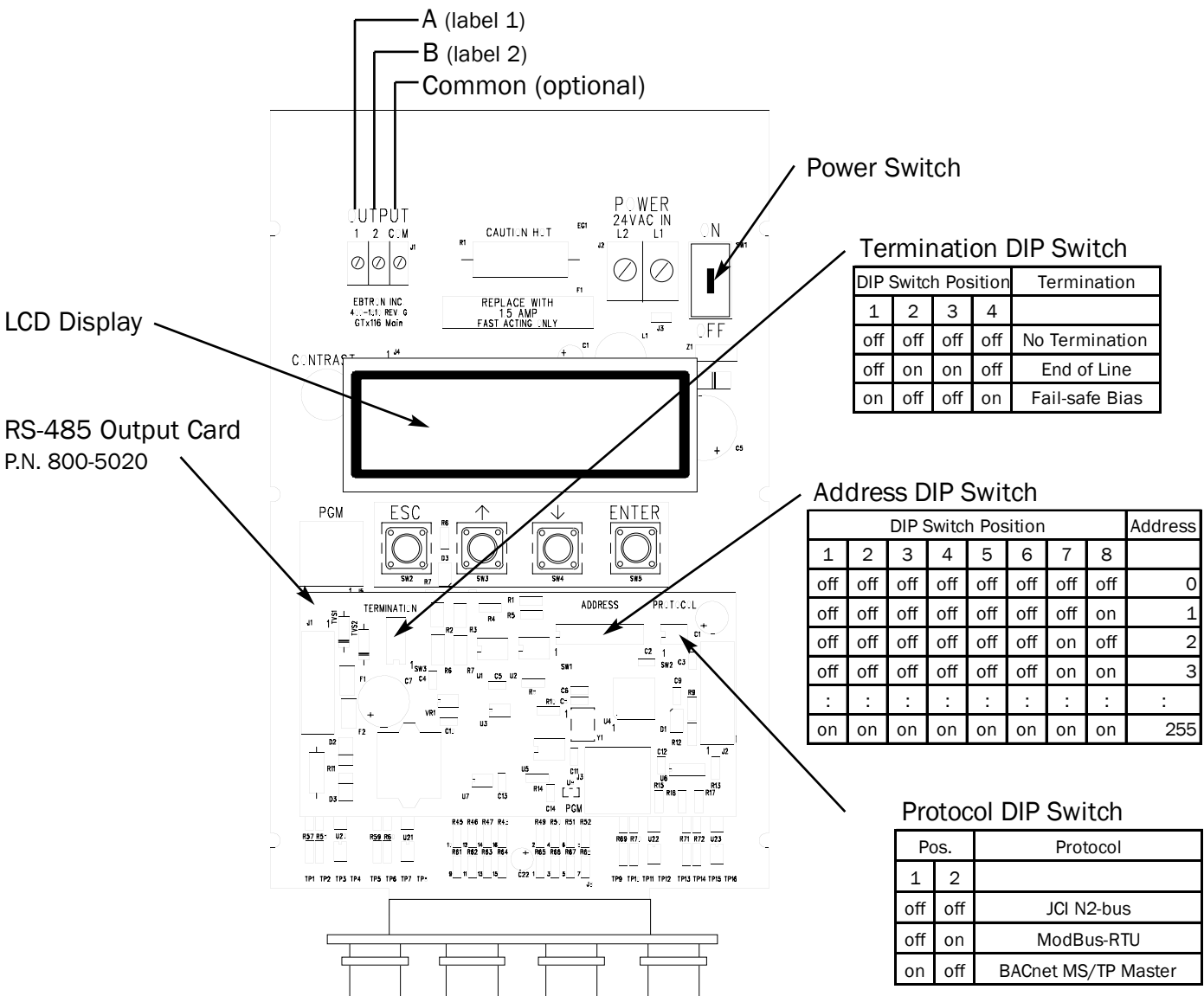

Each transmitter must be configured for proper protocol, address, and termination prior to power up. The transmitter is factory shipped with the protocol set to the BACnet MS/TP Master, address 1 and no termination. DIP switches are located on the output card (see diagram on previous page).

### SETTING THE NETWORK PROTOCOL

Transmitter protocol can be changed in the field by setting the DIP switch labeled “PROTOCOL” on the Network Output Card.

### SETTING THE TRANSMITTER ADDRESS

Each transmitter must be assigned a **unique** address between 1 and 255 (127 BACnet) prior to power up by setting the DIP switch labeled “ADDRESS” on the Network Output Card. The least significant bit (LSB) is switch position number 8.

### SETTING TRANSMITTER TERMINATION

Transmitter termination can be changed in the field by setting the DIP switch labeled “TERMINATION” on the Network Output Card. Termination options are “No Termination”, “End of Line” or “Fail-safe Bias”.



If the DIP switches are moved after power up, the transmitter must be turned off and then on for the new switch positions to be activated.

## BACnet MS/TP



### OBJECTS

Baud Rates: 9600, 19200, 38400, 76800 bps

Type	Description	Default Units
Device	Device Object	
Analog Input	Airflow	FPM
Analog Input	Differential Pressure	in.w.g.
Analog Input	Temperature	°F
Analog Value	Area	sq.ft.

## ModBus RTU

### REGISTER MAP ModBus®

Baud Rate: 9600 bps

Function	Register	Length	Units	Point Description	Range/Value
04	30001	2 <sup>a</sup>	FPM	Airflow	0 to 15,000
04	30003	2 <sup>a</sup>	in.w.c.	Differential Pressure	-2.5 to +2.5
04	30005	2 <sup>a</sup>	°F	Temperature	-20 to +160
04	30007	2 <sup>b</sup>	FPM	Airflow	0 to 15,000
04	30009	2 <sup>b</sup>	in.w.c.	Differential Pressure	-2.5 to +2.5
04	30011	2 <sup>b</sup>	°F	Temperature	-20 to +160
02	10001	1 <sup>c</sup>		Status	0:OK, 1:Trbl.

<sup>a</sup>IEEE Floating Point (low word, high word)

<sup>b</sup>IEEE Floating Point (high word, low word)

<sup>c</sup>Binary (1 byte total)

## JCI N2-Bus



### POINT MAP

Baud Rate: 9600 bps

NPT <sup>1</sup>	NPA <sup>2</sup>	Units	Point Description	Range/Value
AI	1	FPM	Airflow	0 to 15,000
AI	2	in.w.c.	Differential Pressure	-2.5 to +2.5
AI	3	°F	Temperature	-20 to +160
BI	1		Status	0:OK, 1:Trbl.

<sup>1</sup>Network Point Type

<sup>2</sup>Network Point Address

### GTE116 Ethernet Output Transmitters

The GTE116 provides a full duplex IEEE 802.3 ethernet interface with automatic re-transmission on collision and cyclic redundancy checking on network data. An on-board microcontroller performs over 7 million instructions per second to insure minimal network latency. Link status as well as network activity are available via on-board LED indicators.

To wire the output signal, slide the cover plate up and out of the extruded chassis. Make sure that the power switch is in the “OFF” position. Connect the 10base-T ethernet connection (RJ45) to the female connector on the output card as indicated in the figure below.

Each transmitter must be configured for proper protocol prior to power up. The transmitter is factory shipped with the protocol set to the BACnet Ethernet. The DIP switch is located on the output card (see diagram below).

### Ethernet Output Circuit Diagram

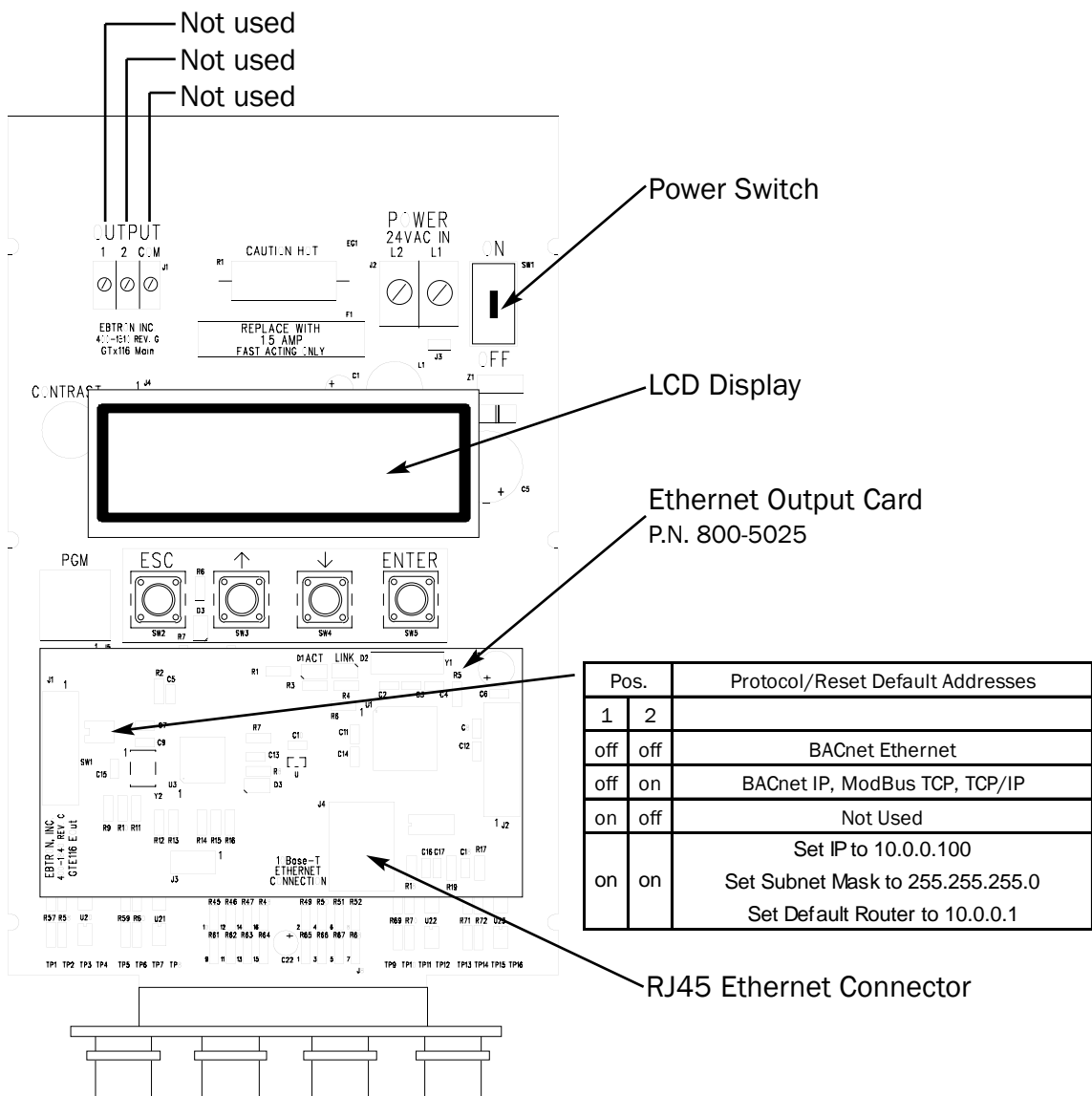

## IP SETUP FOR BACnet IP and TCP/IP (see Register Map for ModBus®)

Setup requires writing a text string to the device object location property (BACnet) or through your web browser (TCP/IP).

BACnet® IP	TCP/IP
IP Address text string: SETIP{address}	http://{ipaddress}/SETIP{address}
Subnet Mask text string: SETMK{address}	http://{ipaddress}/SETMK{address}
Default Router text string: SETRT{address}	http://{ipaddress}/SETRT{address}

where the address format = wwwxxxxyyzzz example: 10.0.0.3 enter as 010000000003

## RESETTING TO THE FACTORY DEFAULTS (BACnet® IP, ModBus® TCP and TCP/IP only)

Addresses can be reset using the GTE116 hardware. First, turn the power switch on the main circuit card to the “OFF” position. Set SW1 to pos1=on, pos2=on. Turn the power to the “ON” position for 1 second or more. Turn the power switch to the “OFF” position and set SW1 to the proper protocol for the network (see SW1 settings on previous page).



If the DIP switches are moved after power up, the transmitter must be turned off and then on for the new switch positions to be activated.

## BACnet® Ethernet & BACnet® IP

OBJECTS 

Type	Description	Default Units
Device	Device Object	
Analog Input	Airflow	FPM
Analog Input	Differential Pressure	in.w.g.
Analog Input	Temperature	°F
Analog Value	Area	sq.ft.

## ModBus TCP

### REGISTER MAP

Function	Register	Length	Units	Point Description	Range/Value
04	30001	2 <sup>a</sup>	FPM	Airflow	0 to 15,000
04	30003	2 <sup>a</sup>	in.w.c.	Differential Pressure	-2.5 to +2.5
04	30005	2 <sup>a</sup>	°F	Temperature	-20 to +160
04	30007	2 <sup>b</sup>	FPM	Airflow	0 to 15,000
04	30009	2 <sup>b</sup>	in.w.c.	Differential Pressure	-2.5 to +2.5
04	30011	2 <sup>b</sup>	°F	Temperature	-20 to +160
01	00001	1 <sup>c</sup>		Status	0:OK, 1:Trbl.
03	40001	4 <sup>c</sup>		IP Address	
03	40005	4 <sup>c</sup>		Subnet Mask	
03	40009	4 <sup>c</sup>		Default Router	

<sup>a</sup>IEEE Floating Point (low word, high word)

<sup>b</sup>IEEE Floating Point (high word, low word)

<sup>c</sup>Binary (1 byte total)

## TCP/IP

http://{IPAddress}

http://{IPAddress}/DP.htm

EBTRON GTE116		
Status	FPM	F
Normal	1210.29	80.84

EBTRON GTE116		
Status	Dynamic Pressure	F
Normal	-0.48121	80.01

### GTL116 LonWorks® Output Transmitters

The GTL116 has a full featured LonWorks® compatible interface. It uses an FFT-10A, 78KBaud free topology network interface that is high speed and relatively insensitive to network wiring topology. The GTL116 may be pre-configured using the GTL116.XIF file available for download at [www.EBTRON.com](http://www.EBTRON.com) or configured at installation time by direct LonWorks® parameter upload from the GTL116 transmitter. A service push-button and LED are provided for standard installation. A “wink” LED is provided for easy device identification.

To wire the output signal, slide the cover plate up and out of the extruded chassis. Make sure that the power switch is in the “OFF” position. Network cables should be connected to the small, three position output terminal labeled “OUTPUT” on the upper left hand side of the main circuit board. Wires should be connected to terminals 1 and 2 only.

### LonWorks® Output Circuit Diagram

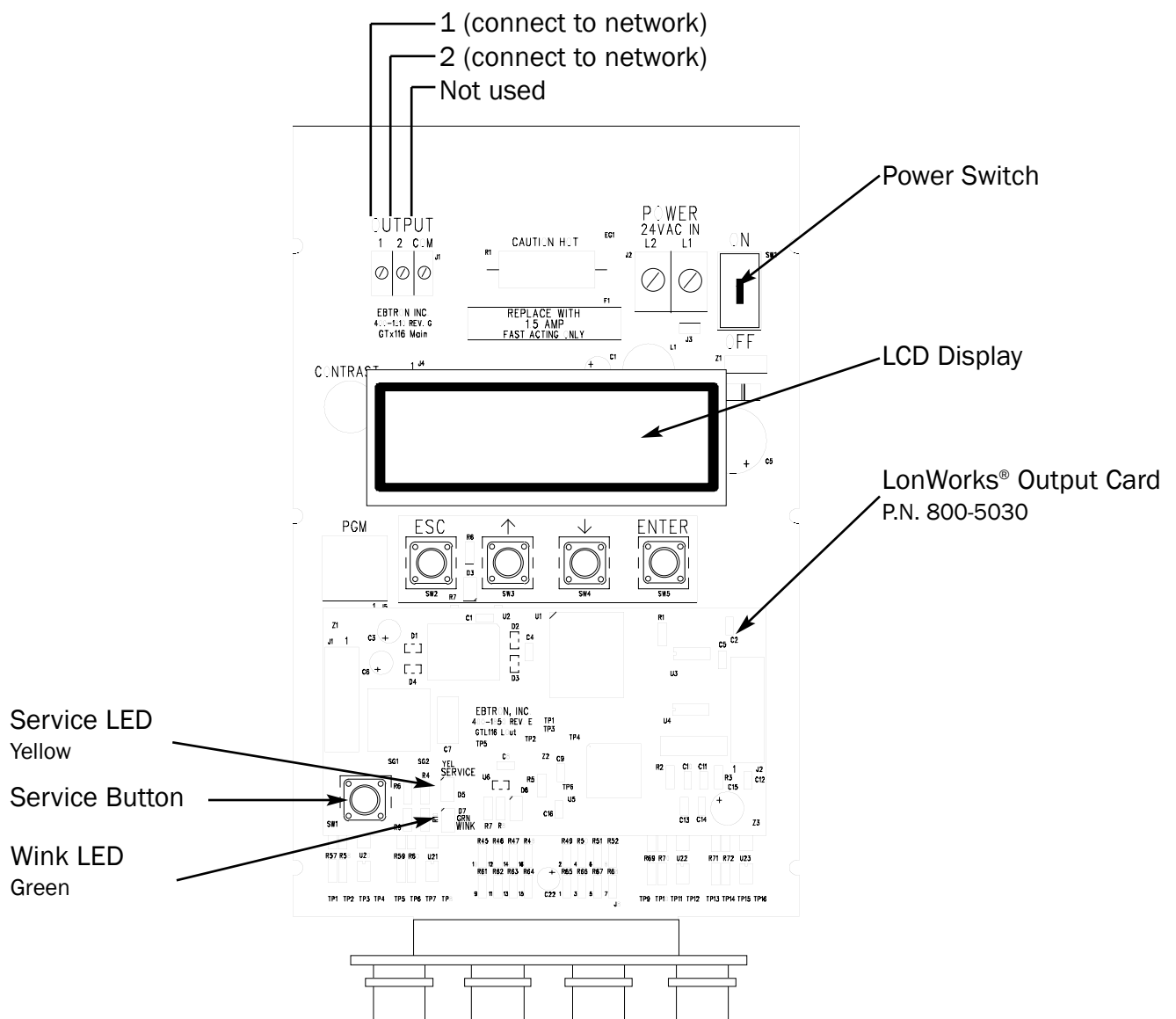

## LonWorks® Configuration Variables

Certain network configuration variables must be set to enable the LonWorks® output card to request data from the GTL116 transmitter. Set only the required variables for the information you will be using. The minimum value for these variables is 0.3 seconds. If set to a shorter time, the card will use 0.3 seconds. The default value for these variables is zero, or "off". The configuration variables are:

nciVSampleTime – Velocity/Flow data from GTX116.

nciTSampleTime – Temperature data from the GTX116.

nciPSampleTime – Pressure data from the GTX116.

nciPSampleTime – Status data from the GTX116.

## LonWorks® GTL116 Node Configuration Table

Variable Name	SNVT	SNVT Index	Type	Resolution	Units	Description
nvoAirVelocity	SNVT_speed_mil	35	Unsigned	0.001	Meters per Second	Air Velocity
nvoAirFlow	SNVT_flow	15	Unsigned	1	Liters per Second	Duct Flow Rate
nvoAirFlowFloat	SNVT_flow_f	53	Floating Point	N/A	Liters per Second	Flow Rate
nciVsndHrtBt	SNVT_time_sec	107	Signed	0.1	Seconds	Max time before velocity/flow variables update
nciVMinOutTm	SNVT_time_sec	107	Signed	0.1	Seconds	Min time before velocity/flow variables update
nciVsendOnDelta	SNVT_speed_mil	35	Unsigned	0.001	Meters per Second	Min velocity change for velocity/flow variable update
nciDuctArea <sup>1</sup>	SNVT_area	110	Unsigned	0.0002	Square Meters	Duct area used to calculate volumetric flow
nciVSampleTime	SNVT_time_sec	107	Signed	0.1	Seconds	Time between samples of Gold Transmitter velocity

<sup>1</sup> Must be set for volumetric flow rate variables nvoAirFlow and nvoAirFlowFloat to be valid.

Variable Name	SNVT	SNVT Index	Type	Resolution	Units	Description
nvoHVACTemp	SNVT_temp_p	105	Signed	0.01	Degrees C	Temperature
nciTMaxSendtime	SNVT_time_sec	107	Signed	0.1	Seconds	Max time for temperature variable update
nciTMinSendtime	SNVT_time_sec	107	Signed	0.1	Seconds	Min time before temperature variable update
nciTMinDelta	SNVT_temp_p	105	Signed	0.01	Degrees C	Min temperature change for temperature variable update
nciTSampleTime	SNVT_time_sec	107	Signed	0.1	Seconds	Time between samples of Gold Transmitter temperature

Variable Name	SNVT	SNVT Index	Type	Resolution	Units	Description
nvoPrecisePress	SNVT_press_p	113	Signed	1	Pascals	Pressure
nvoFloatPress	SNVT_press_f	59	Floating Point	N/A	Pascals	Pressure
nciPMaxSendTime	SNVT_time_sec	107	Signed	0.1	Seconds	Max time for pressure variables update
nciPMinSendTime	SNVT_time_sec	107	Signed	0.1	Seconds	Min time before pressure variables update
nciPMinDelta	SNVT_press_p	113	Signed	0.01	Pascals	Min pressure change for pressure variable update
nciPSampleTime	SNVT_time_sec	107	Signed	0.1	Seconds	Time between samples of Gold Transmitter pressure

Variable Name	SNVT	SNVT Index	Type	Resolution	Units	Description
nciStatSampTim	SNVT_time_sec	107	Signed	0.1	Seconds	Time between samples of Gold Transmitter status

### Start-up

To assure a successful start-up, check that the airflow measuring station and transmitter are installed in accordance to **EBTRON** guidelines.



**Check the physical installation, power connections, and signal wiring prior to turning the power switch to the “on” position.**

Move the power switch to the “ON” position. The transmitter executes a complete self-check each time the power is turned on that takes 10 seconds to complete. Check that the readings at the host control system returns an output that matches the output of the GTx116.

The GTA116 is designed to operate on “POWER-UP”. Default output signals are set to 4-20mA. No field configuration is necessary unless the output signal required is 0-10VDC. The GTN116, GTE116 and GTL116 must be properly configured based on the system network protocol. Review the section for the corresponding transmitter output card in the *SIGNAL WIRE CONNECTIONS* section or contact **EBTRON** Customer Service, toll free, at 800-232-8766.

### Operation

#### Transmitter Initialization

The GTx116 Transmitter automatically initializes at power-up and conducts full system diagnostics. Under normal conditions, there is no reason to enter the *Initialization Mode*. The transmitter should only be initialized if one of the actions listed below are required. To enter the *Initialization mode*, simultaneously press and release the “ENT” and “ESC” buttons during the first 10 seconds after transmitter power-up. Navigate through the menus using the flow chart below.

**Press and release Enter and Escape during first 10 seconds of operation to select**

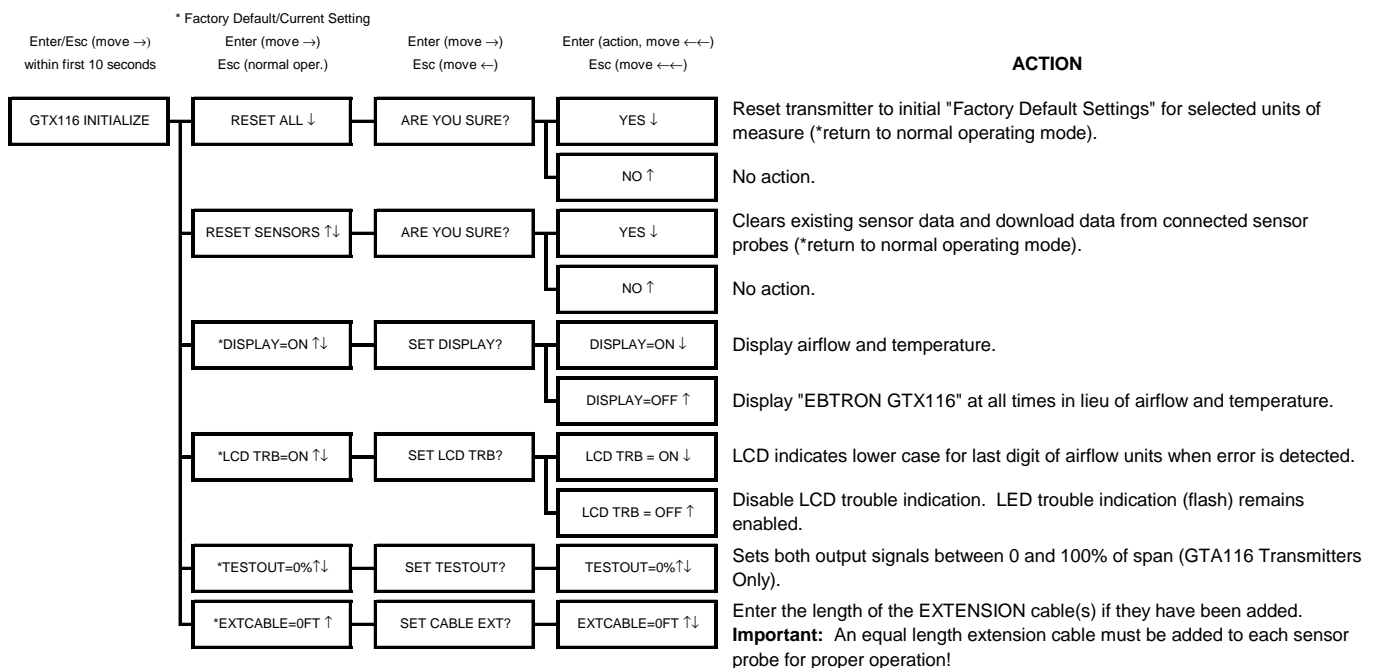

## Changing the System of Units

The GTx116 Transmitter is normally provided with the system of units set to I-P. To change to S.I., simultaneously press and release the “UP” and “DOWN” arrow buttons during normal operation. “IP/SI UNITS” will be indicated on the LCD display. Press “ENT” twice and use the “UP” and “DOWN” arrow buttons until the system of units desired is indicated. Press the “ENT” button to select changes then press “ESC” to return to the normal operating mode. Refer to the flow chart below.

Press and release ↑/↓ during normal operation to select

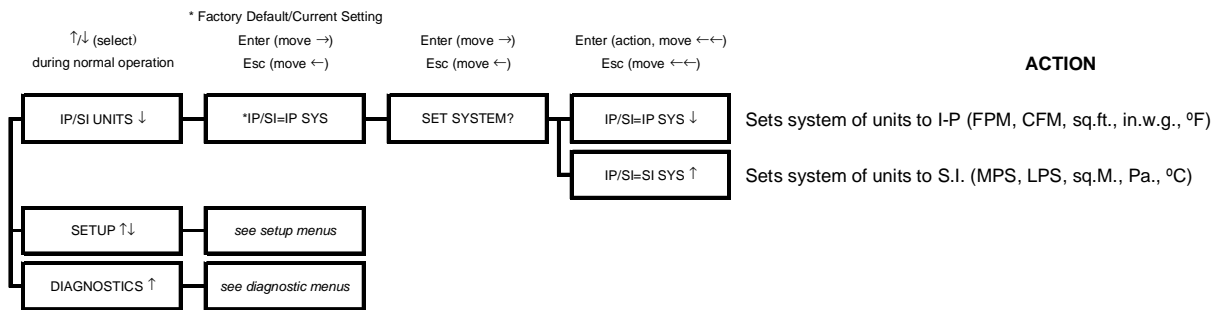

## Changing Factory Default Settings

The GTx116 Transmitter has been setup and tested at the factory and is fully operational when sensor probes are connected and power is applied by turning the power switch to the “ON” position. The transmitter automatically determines the type of sensors connected and defaults to predetermined factory settings. Factory settings can easily be changed in the field by entering the *Main Menu* by simultaneously pressing and releasing the “UP” and “DOWN” buttons while the transmitter is in its normal operating mode. The *Setup Menu* for the corresponding sensor probe connected (-P, -F or -B) will automatically be displayed in the *Setup Menu*. Navigate through the menu using the Setup Menu flow chart to make changes to the transmitter configuration. The settings take effect immediately.

## Output Scaling

### Factory Defaults for GP1 (-P), GF1 (-F), GB1 (-B) Sensor Probes

Display	Sensor Type	Description	I-P	S.I.
*LCDU/M=	ALL	Airflow units of measure	FPM	MPS
*AREA=	-P and -F	Free area where station is located	0.00 sq.ft.	0.000 sq.meters
*K=	-B	Output 1 correction factor	0.00	0.000
*DIRECTION=	-B	Output 1 Polarity	BI (bidirectional)	BI (bidirectional)
*OUT1=	ALL	GTA116 output 1 signal (airflow)	4-20mA	4-20mA
*OUT1U/M=	-B	Output 1 units of measure	FPM	MPS
*FS1=	-P Probes	GTA116 output 1 signal full scale	5,000 FPM	25 MPS
	-F Fan Inlets		10,000 FPM	50 MPS
	-B Bleed Sensors		3,000 FPM	15 MPS
*LL1=	-P and -F	GTA116 low limit cutoff	0 FPM	0 MPS
*LL1=	-B (airflow)		0 FPM	0 MPS
*LL1=	-B (pressure)		0 in.WC	0 Pa
*OFF-GAIN1=	ALL	Output 1 Offset-Gain On/Off	Off	Off
*GAIN1=	ALL	Output 1 Gain factor	1.000	1.000
*OFFSET1=	ALL	Output 1 Offset factor	0.000 FPM	0.000 MPS
*OG1MODE1=	ALL	Output 1 Offset-Gain Mode	1 (direct entry)	1 (direct entry)
*FILTER1=	ALL	Output 1 Digital Noise Filter	0 (off)	0 (off)
*OUT2=	ALL	GTA116 output 2 signal (temperature)	4-20mA	4-20mA
*MS2=	ALL	GTA116 output 2 signal minimum scale	-20° F	-30° C
*FS2=	ALL	GTA116 output 2 signal full scale	160° F	70° C

**EBTRON**'s Gold Series sensors are individually wind tunnel calibrated between 0 and the factory default full scale to **EBTRON**'s calibration standards that are traceable to the National Institute of Standards and Technology (NIST). All sensors are independent and have "percent of reading" accuracy (i.e. decreasing the full scale does not improve the accuracy of the device). Factory default output scaling for analog output GTA116 transmitters can be changed by entering the setup menu (see: *SETUP MENU OPTIONS*).

### Converting the Output Signal from FPM to CFM (MPS to LPS for S.I. scaling)

The equivalent volumetric flow (CFM or LPS) can easily be determined by multiplying the output velocity (FPM or MPS) by the free area where the airflow measuring station is located (free area x 1000 for MPS output when the area is calculated in square meters). The total free area is printed on the hang-tag of each -P sensor probe. The free area on -F and -B units should be determined after the units are installed.

### Changing the LCD Display from FPM to CFM (MPS to LPS for S.I. scaling)

The GTx116 transmitter is shipped to display velocity (FPM or MPS), not volumetric flow (CFM or LPS) so that transmitters are not required to be matched with sensor probes. To change the LCD for volumetric flow indication, enter the *Setup Menu* and change the menu item "\*LCD1U/M=FPM" to "\*LCD1U/M=CFM" ("\*LCD U/M = MPS" to "\*LCD U/M = LPS" for S.I. units). After changing the display units, you will be prompted to enter the free area, in square feet (square meters for S.I. units), where the airflow measuring station is installed. Changing the display units will not affect the output signal of the transmitter. For -P units, the free area is printed on the hang-tag of each sensor probe. For -F and -B units, the free area should be determined after the units are installed in accordance with each unit's installation guidelines.

### Transmitter Calibration

The GTx116 uses high quality industrial grade components and is designed for years of trouble-free operation. Periodic recalibration of the transmitter is neither required nor recommended.

### Setup Menu Options: -P and -F Sensor Systems

Press and release ↑/↓ during normal operation to select

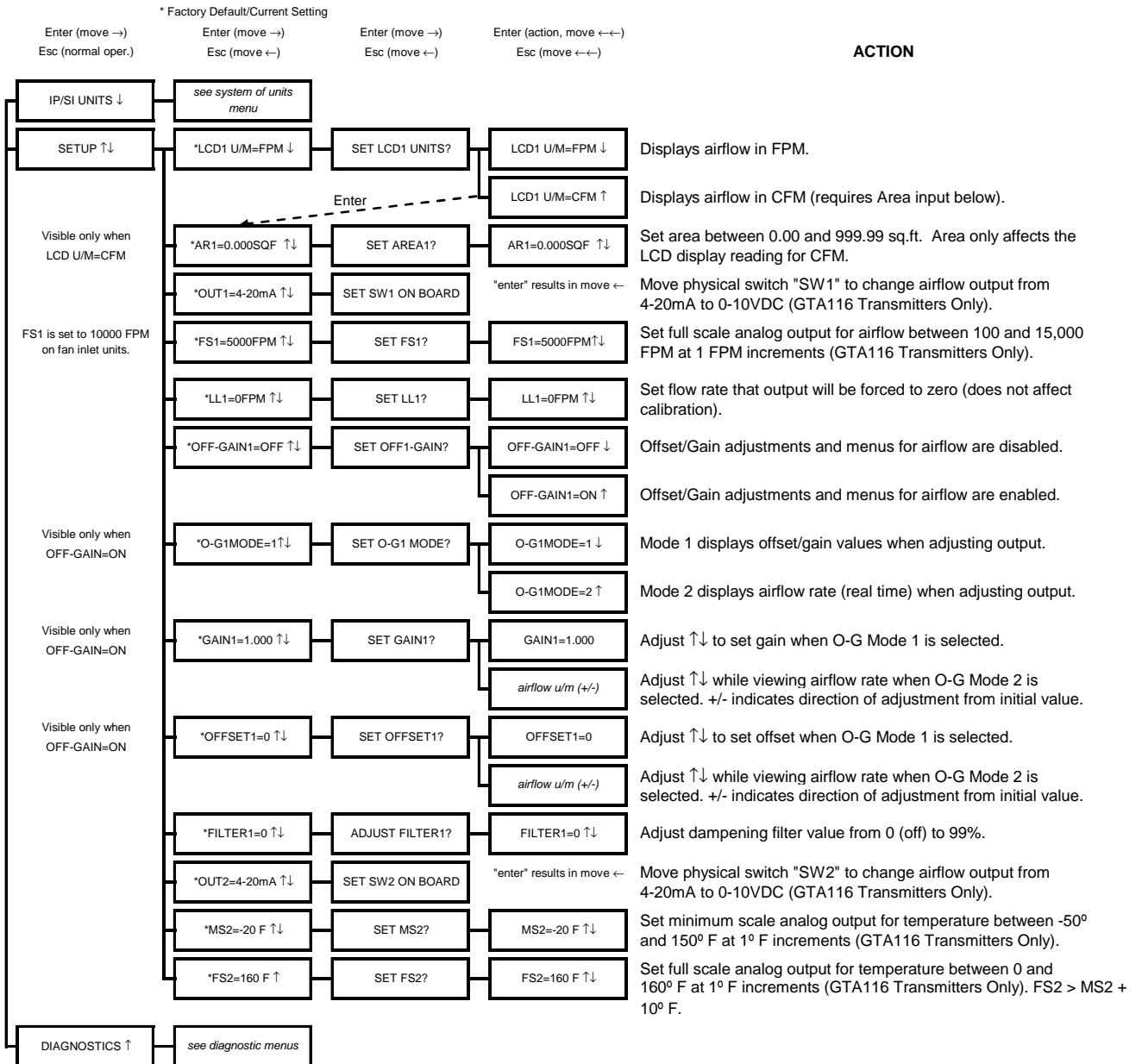

### Setup Menu Options: -B Systems

Press and release  $\uparrow/\downarrow$  during normal operation to select

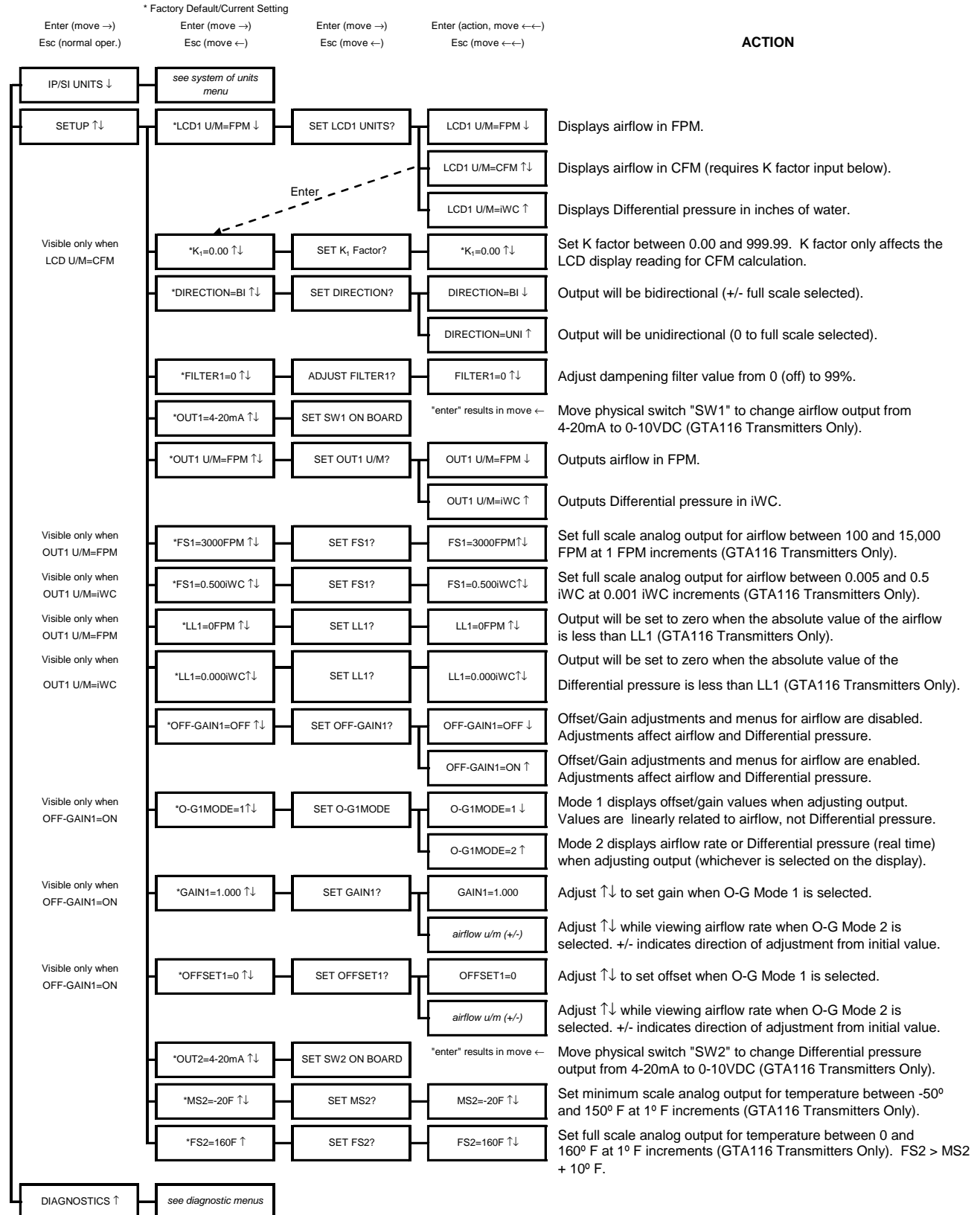

### Setup Menu Options: -P and -F Sensor Systems

Press and release  $\uparrow/\downarrow$  during normal operation to select

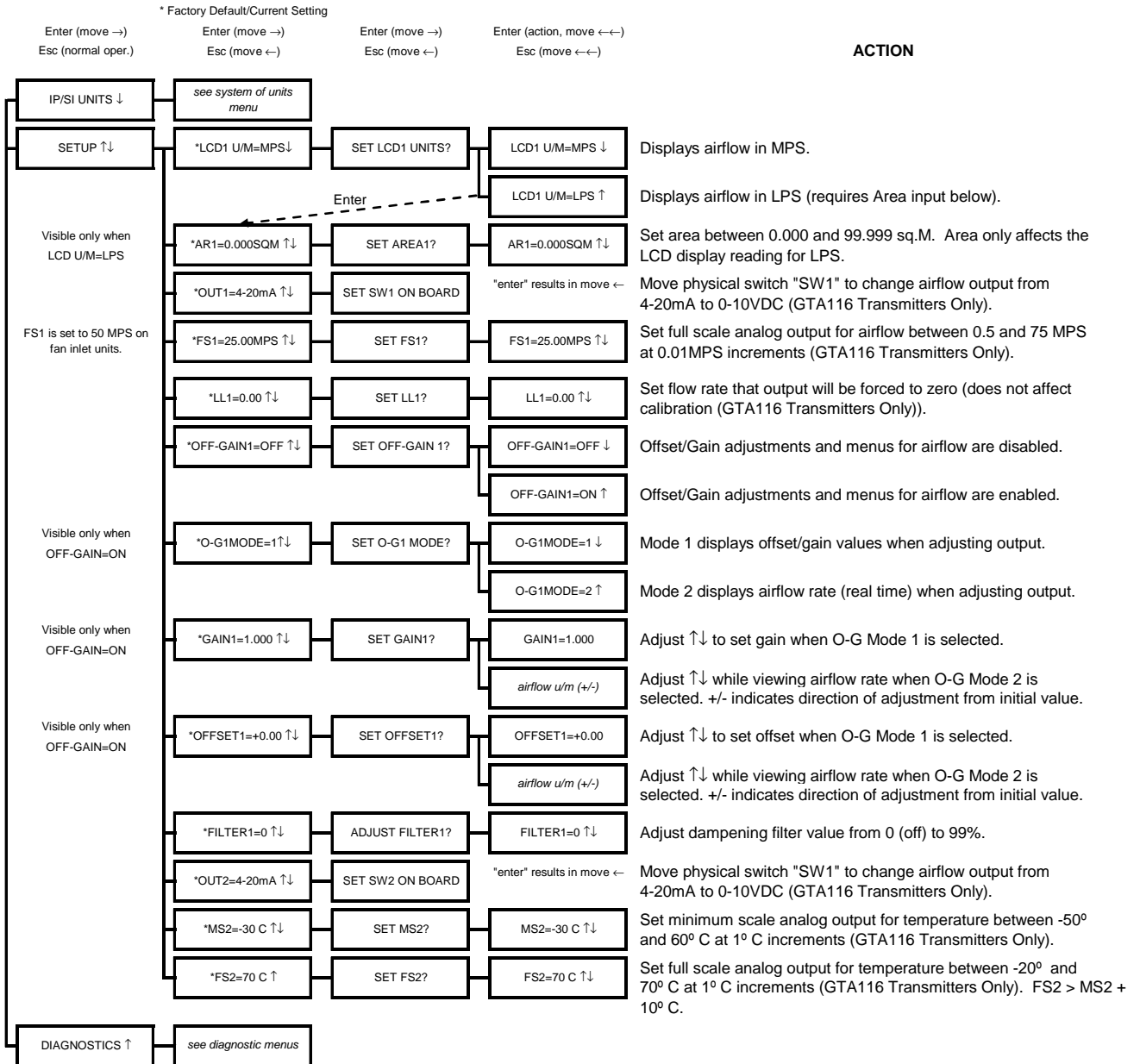

### Setup Menu Options: -B Systems

Press and release  $\uparrow/\downarrow$  during normal operation to select

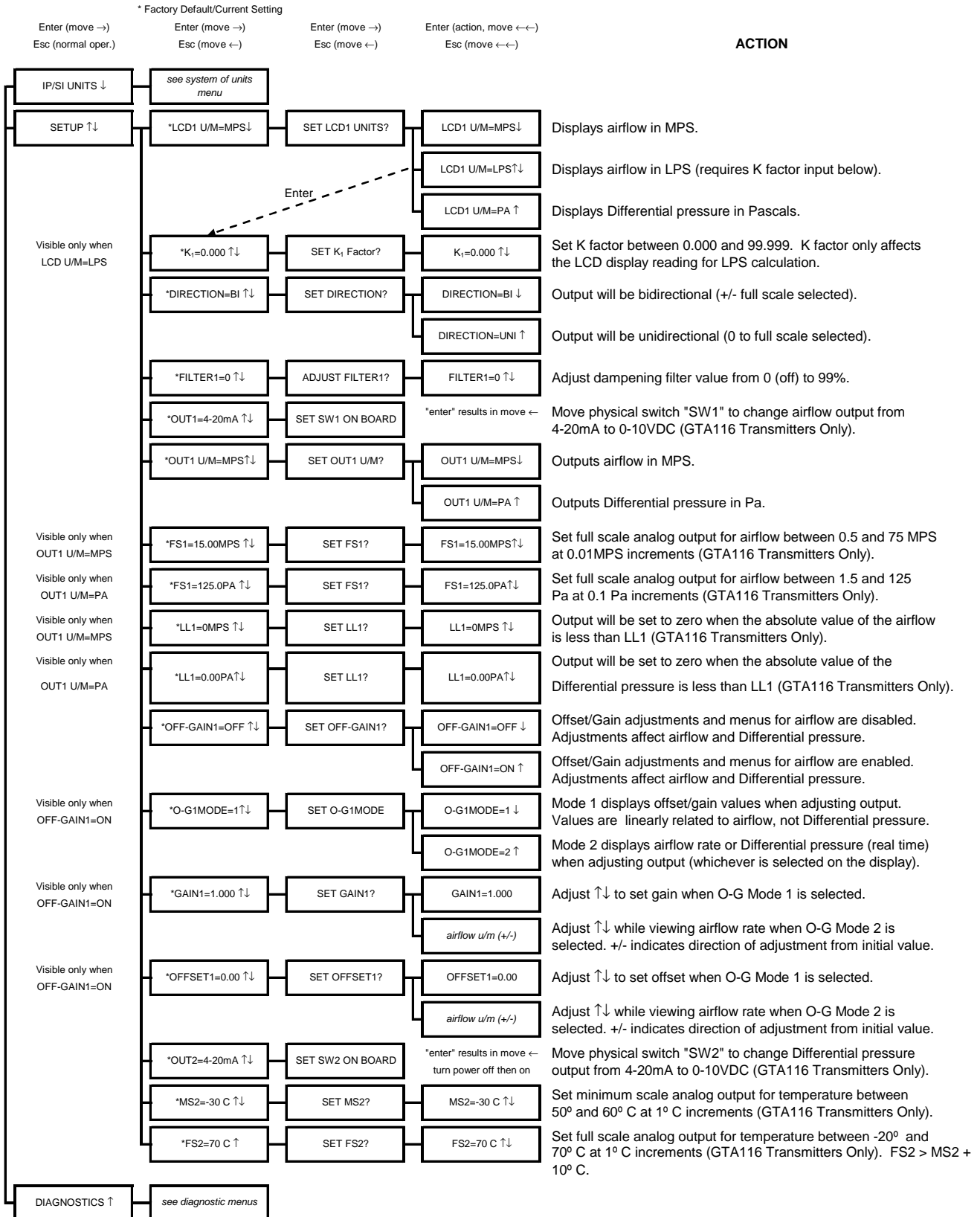

### Navigating through the Diagnostics Menu (all System of Units)

Press and release  $\uparrow/\downarrow$  during normal operation to select

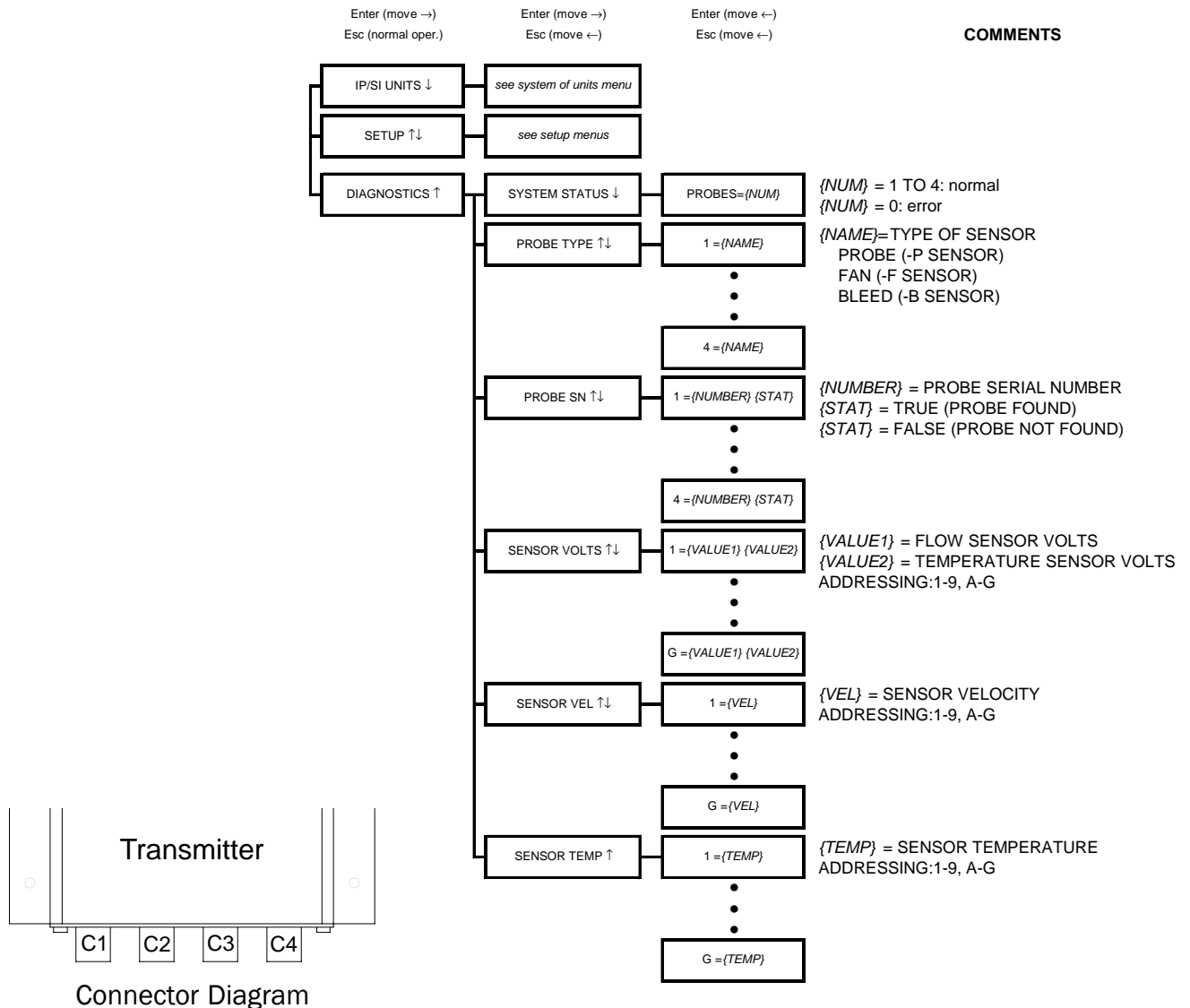

## Sensor Addressing

Airflow and temperature of individual sensors can be displayed from the diagnostic mode. They can also be downloaded directly to a PDA if the infra-red link option has been installed. Sensors are automatically addressed after the power is energized to the transmitter. The probe that is connected to the left most **used** receptacle on the transmitter is probe number 1. The lowest sensor number on the probe is at the end opposite the connecting cable. Up to 16 sensors (addresses 1 to 9 then A to G where G is equal to sensor 16) can be individually viewed.

*Example: Two 4 sensor probes are connected to receptacles C2 and C3 (see Connector Diagram). Sensors 1 to 4 are on C2 and sensors 5 to 8 are on C3. Sensors 1 and 5 are located at the end of the probe opposite from the connecting cable.*

### Adjusting the Factory Calibration

The factory calibration should not require adjustment if the sensor probes are installed in accordance with published installation guidelines on GTx116-PC and GTx116-PB high density airflow measurement systems. However, some installations may not meet placement guidelines or commissioning requirements may dictate field adjustment. Field adjustment may improve the “installed accuracy” of GTx116-PA, GTx116-F and GTx116-B systems when determining volumetric flow rates. Only OUTPUT1, airflow rate or Differential pressure can be adjusted. Make sure that the reference device and technique used to determine the airflow rate in the field is suitable for such measurement. Select a location that is acceptable for the device being used as the reference, recognizing that this may not be the location where the **EBTRON** airflow station is installed. Field measurement accuracy will not be better than  $\pm 5\%$  of reading and can often exceed  $\pm 10\%$ . Do not adjust the output of the GTx116 if the difference between the transmitter and the field measurement is less than 10%. The GTx116 firmware can be adjusted for Output 1 signal “gain” and “offset”. To adjust the output signal “gain”, the “Off-Gain” override must be set to “\*OFF-GAIN1=ON” from the Setup Menu. The adjustments affect both the LCD display and output signal. When “\*OFF-GAIN1=OFF” is set, adjusting the output signal “offset” and/or “gain” will not affect the output of the transmitter.

#### Procedure for 1 Point Field Adjustment

Select an airflow rate that represents a valid operating condition for the system. Set fan speed, dampers and VAV boxes to a fixed speed or position when measurements are taken. Complete the following worksheet to determine the gain setting to be set on the transmitter.

##### Direct Entry of Gain factor (most accurate)

1. Enter the setup menu and set “\*OFF-GAIN1=OFF”. This is the factory default setting and disables any adjustments, returning the unit to its original factory calibration.
2. \_\_\_\_\_ Record the transmitter output by taking the visual reading from the transmitter LCD. Readings can be taken by the host controls if the output signal conversion has been confirmed. Time averaging the data will improve field recalibration.
3. \_\_\_\_\_ Record the reference reading. Make sure that the unit of measure (FPM, CFM, MPS, or LPS) is identical for both the transmitter and the reference. If the unit of measure is velocity (FPM or MPS), make sure that the reference airflow measurement was corrected for the area where the measurement was taken.
4. \_\_\_\_\_ Calculate the gain factor (m):  **$m = \text{line 3} / \text{line 2}$** .
5. Enter the setup menu and set “\*OFF-GAIN1=ON”.
6. Set “\*OG1MODE=1” to enable direct entry of gain and offset values.
7. Set “\*GAIN1={value calculated in line 4}”.
8. Confirm that “\*OFFSET1=0.00”.
9. Press the “ESC” button until you return to the normal operating mode. Field adjustment is complete.

##### Visual Entry of Gain factor

1. Enter the setup menu and set “\*OFF-GAIN1=ON”.
2. Set “\*OG1MODE=2” to enable “live” entry of gain and offset values.
3. Make sure that the unit of measure (FPM, CFM, MPS, or LPS) is identical for both the transmitter and the reference. If the unit of measure is velocity (FPM or MPS), make sure that the reference airflow measurement was corrected for the area where the measurement was taken. Use the “UP” and “DOWN” arrows until the LCD display matches the reference reading. Press “ENTER” to save the new gain value.
4. Press the “ESC” button until you return to the normal operating mode. Field adjustment is complete.

## Procedure for 2 Point Field Adjustment

Select the minimum and maximum airflow rate that the airflow station will encounter as a valid operating condition for the system. Set fan speed, dampers and VAV boxes to a fixed speed or position when measurements are taken. Complete the following worksheet to determine the gain and offset settings to be set on the transmitter.

1. Enter the setup menu and set “\*OFF-GAIN1=OFF”. This is the factory default setting and disables any adjustments, returning the unit to its original factory calibration. MEASUREMENTS MUST BE RECORDED IN FPM (MPS for S.I. units).
  2. Set the minimum airflow rate.
  3. \_\_\_\_\_ Record the transmitter airflow rate by taking the visual reading from the transmitter LCD. Readings can be taken by the host controls if the output signal conversion has been confirmed. Time averaging the data will improve field recalibration.
  4. \_\_\_\_\_ Record the reference airflow rate. Make sure that the unit of measure has been converted to FPM (MPS for S.I. Units). Make sure that the reference airflow measurement was corrected for the area where the measurement was taken.
  5. Set the maximum airflow rate.
  6. \_\_\_\_\_ Record the transmitter airflow rate.
  7. \_\_\_\_\_ Record the reference airflow rate.
  8. \_\_\_\_\_ Calculate the gain factor (m):  $m = (\text{line 7} - \text{line 4}) / (\text{line 6} - \text{line 3})$ .
  9. \_\_\_\_\_ Calculate the offset factor (b):  $b = (\text{line 4} - (\text{line 8} \times \text{line 3}))$ .
- If more than 2 points are available, perform a linear regression on the data to determine the gain and offset.**
10. Enter the setup menu and set “\*OFF-GAIN1=ON”.
  11. Set “\*OG1MODE=1” to enable direct entry of gain and offset values.
  12. Set “\*GAIN1={value calculated in line 8}”.
  13. Set “\*OFFSET1={value calculated in line 9}”.
  14. Press the “ESC” button until you return to the normal operating mode. Field adjustment is complete.

## Adjusting the Low Limit Cutoff

The low limit cutoff forces the output signal for the airflow rate to zero whenever the airflow rate calculated falls below the specified low limit value. This feature is useful on outside air intakes that often indicate false airflow rates, induced by transient wind gusts, when the intake damper is closed and there is no net flow across the damper. Readings of 100 FPM or more are not uncommon on many outside air intake applications when the intake damper is closed and are a result of air movement in the intake plenum (not a malfunction in the airflow measuring device). Setting the low limit to a value significantly below the control setpoint and higher than the threshold flow for false wind readings simplifies control and interpretation of the airflow rate signal on many applications. To set the low limit cutoff, enter the Setup menu and set “\*LL1={desired value in FPM (MPS in S.I.)}”.

## Adjusting the Digital Output Filter

The digital output filter is useful for dampening signal fluctuations resulting from transient wind gusts on outdoor air intakes or excessive turbulence generated from duct disturbances. The digital output filter range can be set between “Off” (0) and 99%. Increasing the filter percentage limits the allowable change of the output signal. To change the amount of filtering, enter the Setup menu and set “\*FILTER1={desired value}”.

### Service

When **EBTRON** equipment is installed in accordance with the manufacture's guidelines, difficulties arising with the equipment are rare. Issues can be easily resolved by following the troubleshooting guides. All devices come with a 3-Year Warranty on Parts and Factory Labor as well as lifetime, toll-free customer support. Customer support is available Monday thru Friday between the hours of 8:00 AM and 4:30 PM ET, at 800-2EBTRON (232.8766). Service forms are available on-line at [www.ebtron.com](http://www.ebtron.com) and when completed, will significantly facilitate our diagnosis of the problem. In many cases the **EBTRON** is diagnosing a system problem rather than an **EBTRON** equipment error. Therefore a sketch of the installation location along with a control sequence of operations is recommended. Fax the completed information to 843.756.1838 before you call or have it available when speaking with a service representative. Address all correspondence to the **EBTRON** Customer Service Department. Additional information is also available from your local **EBTRON** representative.

### All Transmitters

Problem	Possible Cause	Remedy
No LCD display indication and the green LED on the main circuit board is not illuminated.	Power switch not in the "ON" position.	Move the power switch to the "ON" position.
	Improper supply voltage to the power input terminal block.	Make sure that input power wires are connected to positions L1 and L2 of the POWER terminal block and the voltage with the power switch in the "ON" position is between 22.5 and 29 VAC.
	Blown fuse.	Check power wiring. Make sure that multiple devices wired on a single transformer are wired "in-phase". Replace with a 1.5 amp, fast acting fuse only after the problem has been determined and corrected.
No LCD display indication and the green LED on the main circuit board is flashing.	LCD contrast too low.	Turn the contrast potentiometer on the main circuit board "clockwise".
The LCD display is scrambled or there is no LCD display indication after touching the switches, LCD display or circuit board.	Static electricity.	Touch an earth-grounded object, such as a duct, to discharge static electricity then reset the power. Avoid direct contact with the LCD display or circuit board.
The LCD display indicates "No Probes".	The power switch on the transmitter was moved to the "ON" position before the sensor probes were connected.	Reset the power by moving the power switch from the "ON" to "OFF" position and then back to the "ON" position.
The LCD display indicates "DiffSensor Type".	Sensor probes have been mismatched.	Transmitters must have the same sensor type connected (GP1, GF1 or GB1 sensor probes).
The LCD display indicates "Too Many Sensors".	A probe with 5 or more sensors has been connected to a 'Type B' transmitter with 4 receptacles.	Probes with 5 or more sensors are shipped with and require a 'Type A' transmitter with 2 receptacles.
The last digit of the flow rate unit is displayed as a lower case letter.	The sensor detection system has detected one or more malfunctioning or missing sensors.	Check sensor probe cable connections. If sensor probe connections look OK and match the number of sensor probes indicated on each probes hang tag, please call <b>EBTRON's</b> customer service department or visit us at <a href="http://www.ebtron.com">www.ebtron.com</a> .
	A probe with 5 or more sensors has been connected to a 'Type B' transmitter with 4 receptacles.	Probes with 5 or more sensors are shipped with and require a 'Type A' transmitter with 2 receptacles.
The green LED on the main circuit board is "ON" but not flashing.	The microprocessor is not running.	Reset the power by moving the power switch from the "ON" to "OFF" position and then back to the "ON" position.
The green LED on the main circuit board is flashing at 1-second intervals.	No problem, normal operation.	No remedy required.
The green LED on the main circuit board is flashing at 2-second intervals.	The sensor detection system has detected one or more malfunctioning or missing sensors.	Check sensor probe cable connections. If sensor probe connections look OK and match the number of sensor probes indicated on each probe's hang tag, please call <b>EBTRON's</b> customer service department or visit us at <a href="http://www.ebtron.com">www.ebtron.com</a> .
	A probe with 5 or more sensors has been connected to a 'Type B' transmitter with 4 receptacles.	Probes with 5 or more sensors are shipped with and require a 'Type A' transmitter with 2 receptacles.
The transmitter indicates airflow when the HVAC system is not operating.	Sensors are sensitive and can measure very low air velocities. If a reading is indicated, there is airflow present where the airflow measuring station is located.	Do not attempt to adjust zero ("offset"). Doing so will result in an error in airflow measurement. The Low Limit airflow cutoff value can be set to force the output signal to zero.

### GTA116 Transmitter: Analog Output

Problem	Possible Cause	Remedy
No output signal can be measured at the OUTPUT terminal block of the GTA116 transmitter.	Output card is not securely mounted on main circuit board.	Turn the transmitter power "OFF" and press the output card firmly onto main circuit board. Turn the transmitter power back "ON".
	Blown output fuse (output 1 and output 2 are fused and protected independently on GTA116 transmitters).	Make sure that power has not been connected to the output terminal block. Correct the problem and replace with 0.125 amp, fast acting fuse only.  Make sure that your host control system is not configured for a 2-wire device (no excitation voltage should be present on the signals from the host controls). Correct the problem and replace with 0.125 amp, fast acting fuse only.
	The Low Limit airflow cutoff value is above the actual airflow reading.	Decrease the Low Limit airflow cutoff value in the Setup menu until it is below the actual airflow reading.
The output signal on the GTA116 transmitter fluctuates while the flow and/or temperature reading on the LCD are steady.	Electrical interference from other devices is creating noise in the signal wires to the host control system.	The output signal wiring must be shielded. Individually ground one or more of the following points: the signal wire shield at host controls, signal wire shield at the transmitter, or L2 of the power terminal block of the GTA116.
The LCD display does not match the readings indicated by the host control system.	The scaling in the host control system is incorrect.	Compare the current configuration of the transmitter with that of the host control system. Compare the minimum and full scale settings for each output by navigating through the Setup menu.

### GTN116 Transmitter: RS485 Output

Problem	Possible Cause	Remedy
The host control system is unable to communicate with the GTN116 transmitter.	Output card is not securely mounted on main circuit board.	Turn the transmitter power "OFF" and press the output card firmly onto main circuit board. Turn the transmitter power back "ON".
	The network signal wiring is not properly connected to the GTN116 transmitter or the host controls.	Verify that the network signal wires are connected to the proper positions of the OUTPUT terminal block on the GTN116 transmitter and the host controls. On the GTN116 transmitter OUTPUT terminal block, position 1 is for A, 2 for B and COM for common.
	The network protocol has not been properly set on the GTN116.	Set network protocol based on your network requirements and reset transmitter power. See the transmitter installation and configuration guide for settings.
	The transmitter address has not been properly set on the GTN116.	Set the address based on network requirements and reset the transmitter power. See the transmitter installation and configuration guide for settings. Note that each address must be unique for the network.
	The transmitter termination has not been properly set on the GTN116.	Set the transmitter termination based on your network requirements and reset the transmitter power. See the transmitter installation and configuration guide for settings.
The LCD display does not match the readings indicated by the host control system.	The Area or K factor in the GTN116 transmitter does not match that of the host controls.	Compare the value for the Area or K factor setting of the GTN116 transmitter with that of the host control system and make adjustments so that they match.
The returned value for airflow is zero when there is airflow indicated on the LCD display of the GTN116 transmitter.	The Low Limit airflow cutoff value is above the actual airflow reading.	Decrease the Low Limit airflow cutoff value in the Setup menu until it is below the actual airflow reading.
The status point from the GTN116 transmitter has a Trouble value.	The sensor detection system has detected one or more malfunctioning or missing sensors.	Check sensor probe cable connections. If sensor probe connections look OK and match the number of sensor probes indicated on each probe's hang tag, please call <b>EBTRON's</b> customer service department or visit us at <a href="http://www.ebtron.com">www.ebtron.com</a> .
	A probe with 5 or more sensors has been connected to a 'Type B' transmitter with 4 receptacles.	Probes with 5 or more sensors are shipped with and require a 'Type A' transmitter with 2 receptacles.
There is no value for the differential pressure point.	Differential pressure is only available from transmitters that have <b>EBTRON's</b> Bi Directional Bleed Airflow Sensors connected.	If a differential pressure measurement is required, contact your local <b>EBTRON</b> Representative about <b>EBTRON's</b> Bi Directional Bleed Airflow Sensor.

### GTE116 Transmitter: Ethernet Output

Problem	Possible Cause	Remedy
The host control system or web browser is unable to communicate with the GTE116 transmitter.	Output card is not securely mounted on main circuit board.	Turn the transmitter power "OFF" and press the output card firmly onto main circuit board. Turn the transmitter power back "ON".
	There is no link to the network indicated by the LINK LED on the output card.	The LINK LED indicates a valid connection to the network when it is lit. If the LED is not lit, check your network cabling and connections between the GTE116 transmitter and the network switch or hub.
	The network protocol has not been properly set on the GTE116.	Set network protocol based on your network requirements and reset transmitter power. See the transmitter installation and configuration guide for settings.
	The transmitter address has not been properly set on the GTE116.	Set the address based on your network requirements. See the transmitter installation and configuration guide for settings. Note that each address must be unique for the network.
The LCD display does not match the readings indicated by the host control system.	The area factor in the GTE116 transmitter does not match that of the host controls.	Compare the value for the area or K factor setting of the GTE116 transmitter with that of the host control system and make adjustments so that they match.
The returned value for airflow is zero when there is airflow indicated on the LCD display of the GTN116 transmitter.	The Low Limit airflow cutoff value is above the actual airflow reading.	Decrease the Low Limit airflow cutoff value in the Setup menu until it is below the actual airflow reading.
The status register from the GTE116 transmitter has a Trouble value.	The sensor detection system has detected one or more malfunctioning or missing sensors.	Check sensor probe cable connections. If sensor probe connections look OK and match the number of sensor probes indicated on each probe's hang tag, please call <b>EBTRON's</b> customer service department or visit us at <a href="http://www.ebtron.com">www.ebtron.com</a> .
	A probe with 5 or more sensors has been connected to a 'Type B' transmitter with 4 receptacles.	Probes with 5 or more sensors are shipped with and require a 'Type A' transmitter with 2 receptacles.
There is no value for the differential pressure point.	Differential pressure is only available from transmitters that have EBTRON's Bi Directional Bleed Airflow Sensors connected.	If a differential pressure measurement is required, contact your local <b>EBTRON</b> Representative about <b>EBTRON's</b> Bi Directional Bleed Airflow Sensor.

### GTL116 Transmitter: LonWorks® Output

Problem	Possible Cause	Remedy
The host control system is unable to communicate with the GTL116 transmitter.	Output card is not securely mounted on main circuit board.	Turn the transmitter power "OFF" and press the output card firmly onto main circuit board. Turn the transmitter power back "ON".
	The network signal wiring is not properly connected to the GTL116 transmitter or the host controls.	Verify that the network signal wires are connected to the proper positions of the OUTPUT terminal block on the GTL116 transmitter and the host controls. Wires should only be connected to positions 1 and 2 on the output terminal block.
	The LonWorks® network database has not been configured for the GTL116 transmitter.	The LonWorks® network database may be pre-configured using the GTL116.XIF file available for download at <a href="http://www.ebtron.com">www.ebtron.com</a> or configured at installation time by direct LonWorks® parameter upload from the GTL116 transmitter.
The GTL116 transmitter is not providing values for any of the variables.	The required network configuration variables have not been set.	Certain network configuration variables must be set to enable the LonWorks® output card to request data from the GTL116 transmitter. See the transmitter installation and configuration guide for settings.
There is no value for the differential pressure variables.	Differential pressure is only available from transmitters that have <b>EBTRON's</b> Bi Directional Bleed Airflow Sensors connected.	If a differential pressure measurement is required, contact your local <b>EBTRON</b> Representative about <b>EBTRON's</b> Bi Directional Bleed Airflow Sensor.
The LCD display does not match the readings indicated by the host control system.	The area factor in the GTL116 transmitter does not match that of the host controls.	Compare the value for the area or K factor setting of the GTL116 transmitter with that of the host control system and make adjustments so that they match.
The returned value for airflow is zero when there is airflow indicated on the LCD display of the GTN116 transmitter.	The Low Limit airflow cutoff value is above the actual airflow reading.	Decrease the Low Limit airflow cutoff value in the Setup menu until it is below the actual airflow reading.
The status variable from the GTL116 transmitter has a Trouble value.	The sensor detection system has detected one or more malfunctioning or missing sensors.	Check sensor probe cable connections. If sensor probe connections look OK and match the number of sensor probes indicated on each probe's hang tag, please call <b>EBTRON's</b> customer service or visit us at <a href="http://www.ebtron.com">www.ebtron.com</a> .
	A probe with 5 or more sensors has been connected to a 'Type B' transmitter with 4 receptacles.	Probes with 5 or more sensors are shipped with and require a 'Type A' transmitter with 2 receptacles.

